



GR-700EX

Left hand steering

GENERAL DATA

CRANE CAPACITY	70,000 kg at 3.0 m	
BOOM	5-section, 11.5 m - 44.0m	
DIMENSION		
Overall length	approx.	14,075 mm
Overall width	approx.	3,315 mm
Overall height	approx.	3,800 mm
MASS		
Gross vehicle mass	approx.	48,315 kg
— front axle	approx.	24,695 kg
— rear axle	approx.	23,620 kg
PERFORMANCE		
Max. travelling speed	computed	39 km/h
Gradeability(tan θ)	computed	112 % (at stall)
		* 30 %

*Machine should be operated within the limit of engine crankcase design (17°:MITSUBISHI 6M60-TLU3B).

CRANE SPECIFICATIONS

MODEL

GR-700EX

CAPACITY

70,000 kg at 3.0 m

BOOM

5-section full power partially synchronized telescoping boom of round hexagonal box construction with 7 sheaves at boom head. The synchronization system consists of 2 telescope cylinders, extension cables and retraction cables.

Hydraulic cylinders fitted with holding valves.

Fully retracted length 11.5 m

Fully extended length 44.0 m

Extension speed 32.5 m in 145 s

JIB

2-staged swingaround boom extension. Triple offset (3.5°/25°/45°) type. Stores alongside base boom section.

Single sheave at jib head.

Assistant cylinders for mounting and stowing.

Length..... 9.9 m and 17.7 m

SINGLE TOP (AUXILIARY BOOM SHEAVE)

Single sheave. Mounted to main boom head for single line work.

ELEVATION

By a double-acting hydraulic cylinder, fitted with holding valve.

Elevation speed.....-2° to 80° in 77 s

HOIST— Main winch

Variable speed type with grooved drum driven by hydraulic axial piston motor through winch speed reducer. Power load lowering and hoisting.

Equipped with automatic brake (Neutral brake) and counterbalance valve. Controlled independently of auxiliary winch.

Single line pull 54.9 kN {5,600 kgf}

Single line speed 143 m/min (at the 4th layer)

Wire rope..... Spin-resistant type

Diameter x length 19 mm x 247 m

HOIST—Auxiliary winch

Variable speed type with grooved drum driven by hydraulic axial piston motor through winch speed reducer. Power load lowering and hoisting.

Equipped with automatic brake (Neutral brake) and counterbalance valve. Controlled independently of main winch.

- Single line pull54.9 kN {5,600 kgf}
- Single line speed125 m/min (at the 2nd layer)
- Wire rope.....Spin-resistant type
- Diameter x length19 mm x 133 m

SWING

Hydraulic axial piston motor driven through planetary speed reducer. Continuous 360° full circle swing on ball bearing slew ring. Equipped with manually locked/released swing brake.

- Swing speed2.3 min⁻¹ {rpm}

HYDRAULIC SYSTEM

Pumps.....2 variable piston pumps for telescoping, elevating and winches.

Tandem gear pump for steering, swing and optional equipment.

Control valvesMultiple valves actuated by pilot pressure with integral pressure relief valves.

Circuit.....Equipped with air cooled type oil cooler. Oil pressure appears on AML display for main circuit.

Hydraulic oil tank capacity..... approx. 740 liters

FiltersReturn line filter

CRANE CONTROL

By 4 control levers for swing, boom hoist, main winch, boom telescoping or auxiliary winch with 2 control pedals for boom hoist and boom telescoping based on ISO standard layout.

Control lever stands can change neutral positions and tilt for easy access to cab.

CAB

Both crane and drive operations can be performed from one cab mounted on rotating superstructure. One sided one-man type, steel construction with sliding door access and tinted safety glass windows opening at side. Door window is powered control.

Operator's 3 way adjustable seat with headrest and armrest.

TADANO Automatic Moment Limiter (Model:AML-L)

Main unit in crane cab gives audible and visual warning of approach to overload. Automatically cuts out crane motions before overload.

With working range (load radius and/or boom angle and/or tip height and/or swing range) limit function.

Nine functions are displayed.

Digital liquid crystal display:

- Either boom angle or moment %
- Either boom length or potential hook height
- Either actual load radius or swing angle
- Actual hook load
- Permissible load
- Either jib offset angle or number of parts line of rope
- Boom position indicator
- Either outrigger position or on-tire indicator

Bar graphical display:

- Either moment as percentage or main hydraulic pressure (Display changes by alternation key on the AML front panel.)

OUTRIGGERS

4-hydraulically operated H-type outriggers. Each outrigger controlled simultaneously or independently from the cab. Equipped with sight level gauge. Floats mounted integrally with the jacks retract to within vehicle width. All cylinders fitted with pilot check valves. Crane operation with different extended length of each outrigger. Equipped with extension width detector for each outrigger.

- Extended width
 - Fully.....7,200 mm
 - Middle.....6,700 mm
 - Middle.....5,500 mm
 - Minimum.....2,800 mm
- Float size(Diameter).....500 mm

COUNTERWEIGHT

Integral with swing frame (containing removable weight)

- Mass.....7,900 kg

NOTE : Each crane motion speed is based on unladen conditions.

TYPE

Rear engine, left-hand steering, driving axle 2-way selected type (by manual switch).

- 4 x 2 front drive
- 4 x 4 front and rear drive

FRAME

High-tensile steel, all welded mono-box construction.

ENGINE

Model.....MITSUBISHI 6M60-TLU3B [EUROMOT Stage IIIA]

Type.....4 cycle, turbo charged and after cooled, 6 cylinder in line, direct injection, water cooled diesel engine.

Piston displacement7,545 cm³

Bore x stroke118 mm x 115 mm

Max. output.....200 kW {272 PS} at 2,600 min⁻¹ {rpm}

Max. torque785 N-m {80 kgf-m} at 1,400 min⁻¹ {rpm}

TRANSMISSION

Electronically controlled full automatic transmission.

Torque converter driving full powershift with driving axle selector. 6 forward and 2 reverse speeds.

3 speeds - High range - 2 wheel drive ; 4 wheel drive

3 speeds - Low range - 4 wheel drive

AXLES

Front.....Full floating type, steering and driving axle with planetary reduction.

Rear.....Full floating type, steering and driving axle with planetary reduction.

Non-spin differential.

STEERING

Hydraulic power steering controlled by steering wheel.

Four steering modes available:

- 2-wheel front
- 2-wheel rear
- 4-wheel coordinated
- 4-wheel crab

SUSPENSION

FrontRigid mounted to the frame.

Rear.....Pivot mounted with hydraulic lockout cylinders.

BRAKE SYSTEM

ServiceAir over hydraulic disc brakes on all 4 wheels.

Parking / Emergency.....

Spring applied-air released brake acting on input shaft of front axle.

Auxiliary....Electro-pneumatic operated exhaust brake.

ELECTRIC SYSTEM

24 V DC. 2 batteries of 12 V - 120 Ah capacity.

FUEL TANK CAPACITY

300 liters

TIRES

Front29.5 - 25 22PR(OR), Single x 2

Rear.....29.5 - 25 22PR(OR), Single x 2

TURN RADIUS

Min. turning radius (at center of extreme outer tire)

2-wheel steering 11.9 m

4-wheel steering 6.7 m

EQUIPMENT

STANDARD EQUIPMENT

Automatic moment limiter (AML-L)

External lamp (AML)

Pendant type over-winding cutout

Winch automatic fail-safe brake

Winch drum rotation indicator for main and auxiliary winch

Winch drum mirror

Cable follower

5.6 t capacity hook block (swivel hook)

Hook safety latch

Pilot check valves

Holding valves

Counterbalance valves

Hydraulic pressure relief valves

Swing brake

Swing lock (360° swing lock)

Boom angle indicator

Boom elevation foot pedal

Boom telescoping foot pedal

Outrigger extension width detector

Sight level gauge

Hydraulic oil cooler

Electric windshield wiper and washer

Roof window wiper and washer

Power window (Cab door)

Tachometer/Speedometer

3 way adjustable cloth seat with seat belt, headrest and armrest

Cab floor mat

Sun visor (Front and roof)

Automatic drive system

Transmission neutral position engine start

Overshift prevention

Parking braked travel warning

Tilt-telescope steering wheel

Back-up alarm

Air cleaner dust indicator

Air dryer

Water separator with filter

Engine over-run alarm

Hydraulic lockout suspension (Rear)

Non-spin differential (Rear)

Towing eyes - front and rear

OPTIONAL EQUIPMENT

70 t capacity hook block (8 sheaves)

40 t capacity hook block (4 sheaves)

Over - unwinding prevention

Air conditioner (hot water heater and cooler)

Electric fan

Tire inflation kit

Emergency steering

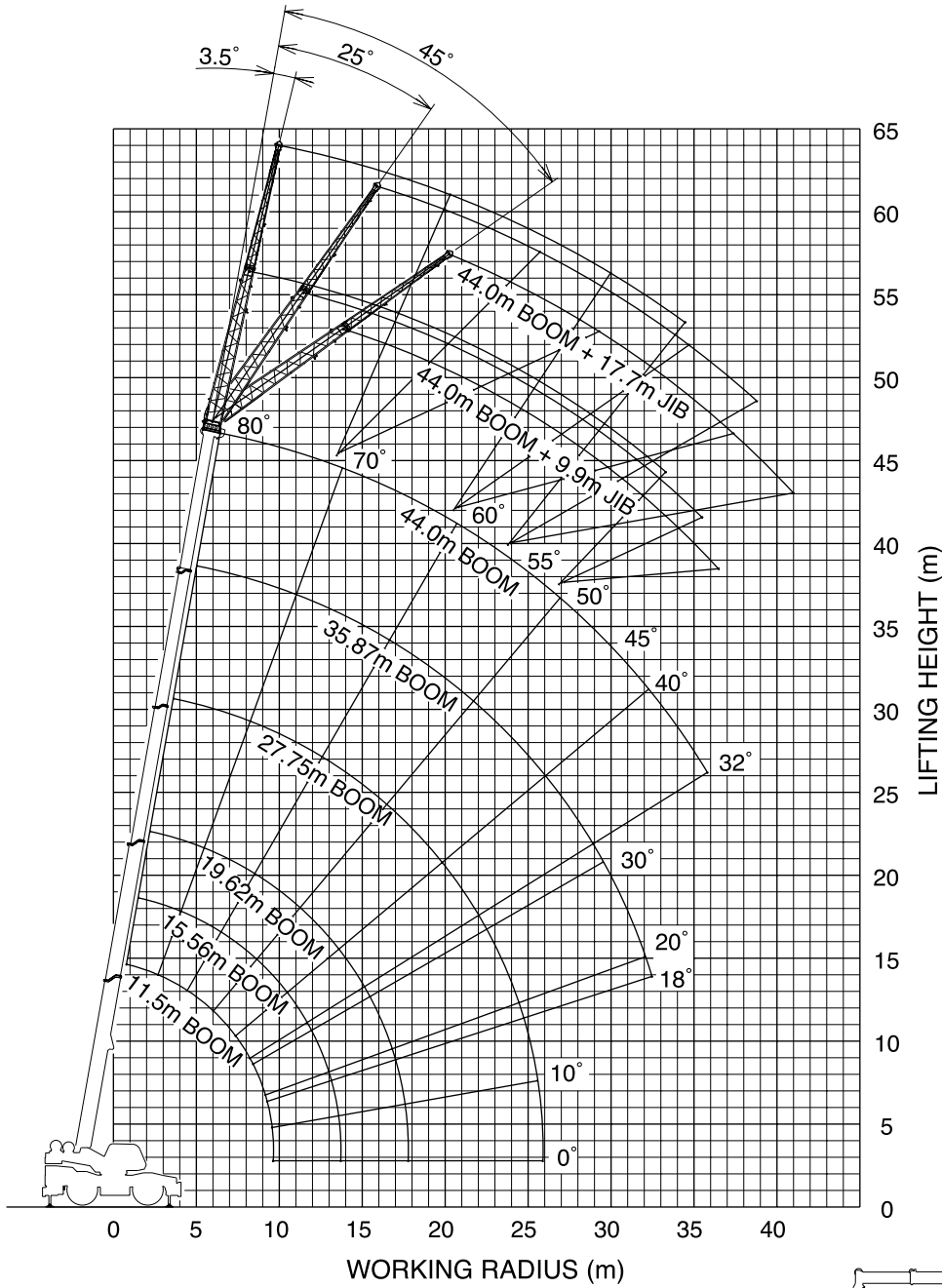

BOOM

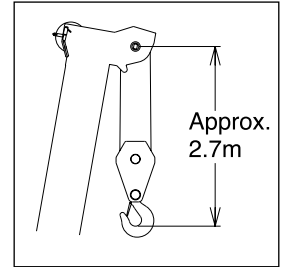

JIB

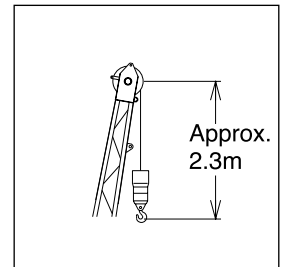

SINGLE TOP

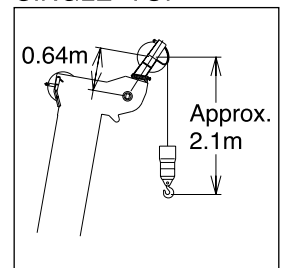

Boom Length

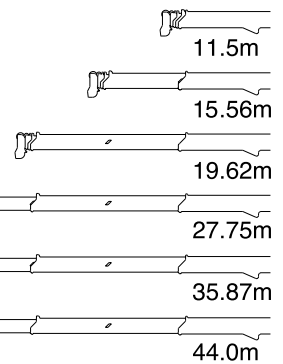

NOTE: The above lifting height and boom angle are based on a straight (unladen) boom, and allowance should be made for boom deflection obtained under laden conditions. The above working range is shown on condition with outriggers fully (7.2m) extended.

RATED LIFTING CAPACITIES ISO4305

SPEC. SHEET NO. GR-700E-1-00212/EX-23

ON OUTRIGGERS

Unit : kg

Outriggers fully extended (7.2m) 360° Rotation												
B \ A	11.50		15.56		19.62		27.75		35.87		44.00	
	C		C		C		C		C		C	
3.0	68.9	70,000	74.9	47,000	78.0	40,000						
3.5	65.9	58,500	72.6	47,000	76.6	40,000						
4.0	63.1	53,600	71.0	47,000	75.3	40,000						
4.5	60.1	49,600	69.0	47,000	73.7	40,000	78.9	20,000				
5.0	57.1	45,200	66.6	43,200	72.2	37,500	77.8	20,000				
5.5	54.0	40,500	64.8	39,400	70.6	35,000	76.8	20,000				
6.0	50.6	36,300	62.6	35,900	69.1	33,000	75.8	20,000	79.5	14,000		
6.5	47.2	32,900	60.7	32,800	67.5	30,700	74.8	20,000	78.7	14,000		
7.0	43.5	30,000	58.2	30,000	65.9	28,300	73.7	20,000	77.9	14,000		
8.0	35.5	25,200	53.6	25,000	62.4	23,700	71.7	19,400	76.4	14,000	79.5	8,000
9.0	24.2	21,300	48.7	20,800	59.1	19,800	69.5	17,900	74.9	14,000	78.0	8,000
10.0			43.6	17,300	55.6	16,600	67.1	16,300	73.3	13,700	77.0	8,000
11.0			37.8	14,500	51.6	14,000	64.9	14,900	71.7	12,500	75.9	8,000
12.0			30.4	12,300	47.6	11,700	62.6	13,300	69.9	11,500	74.7	8,000
13.0			20.9	10,300	43.2	9,900	60.1	11,400	68.3	10,600	73.4	8,000
14.0					38.6	8,500	57.4	9,800	66.5	9,800	72.1	8,000
16.0					26.7	6,100	52.2	7,400	62.9	8,000	69.4	7,400
18.0							46.4	5,700	59.0	6,400	66.5	6,400
20.0							40.1	4,400	54.7	5,100	63.4	5,200
22.0							32.6	3,400	50.6	4,000	60.3	4,300
24.0							23.1	2,500	45.9	3,100	57.1	3,500
26.0									40.8	2,400	53.6	2,800
28.0									35.5	1,900	49.9	2,200
30.0									29.0	1,400	46.2	1,700
32.0									21.2	1,000	42.3	1,300
D	0°						18°			32°		
Telescoping conditions (%)												
2nd boom	0		50		100		100		100		100	
3rd boom	0		0		0		33		66		100	
4th boom	0		0		0		33		66		100	
Top boom	0		0		0		33		66		100	

A: Boom length (m)

B: Load radius (m)

C: Loaded boom angle (°)

D: Minimum boom angle for indicated length (no load)

ON OUTRIGGERS

Unit : kg

Outriggers fully extended (7.2m) 360° Rotation												
C	44.0m Boom + 9.9m Jib						44.0m Boom + 17.7m Jib					
	3.5° offset		25° offset		45° offset		3.5° offset		25° offset		45° offset	
	R	W	R	W	R	W	R	W	R	W	R	W
80°	9.8	4,500	13.7	4,000	16.1	3,400	12.5	2,700	18.3	1,700	22.1	1,000
75°	15.1	4,500	18.7	3,900	20.3	3,300	18.6	2,700	23.7	1,700	27.1	1,000
70°	20.0	4,400	23.0	3,400	24.4	3,000	24.2	2,600	28.8	1,700	31.6	1,000
65°	24.3	3,600	27.2	3,000	28.5	2,700	29.2	2,200	33.6	1,700	35.7	1,000
60°	28.1	2,400	30.9	2,400	32.0	2,200	33.5	1,700	37.8	1,500	39.4	1,000
55°	31.8	1,600	34.1	1,500	35.1	1,500	37.4	1,100	41.3	900	43.0	900
50°	35.2	1,000	37.1	1,000	37.9	900						

Outriggers fully extended (7.2m) 360° Rotation												
C	35.87m Boom + 9.9m Jib						35.87m Boom + 17.7m Jib					
	3.5° offset		25° offset		45° offset		3.5° offset		25° offset		45° offset	
	R	W	R	W	R	W	R	W	R	W	R	W
80°	8.0	5,600	11.6	5,000	13.8	3,800	10.3	3,600	16.5	2,400	20.4	1,500
75°	12.2	5,600	15.5	4,500	17.5	3,600	15.2	3,600	21.1	2,400	24.4	1,500
70°	16.3	5,500	19.1	4,000	20.9	3,400	19.8	3,200	25.2	2,100	28.2	1,500
65°	20.0	4,500	22.6	3,500	24.1	3,000	24.2	2,700	29.1	1,900	31.6	1,500
60°	23.4	3,800	25.8	3,100	27.1	2,800	28.4	2,300	32.6	1,700	34.7	1,500
55°	26.7	2,800	28.8	2,500	29.9	2,600	32.1	2,000	36.0	1,600	37.6	1,400
50°	29.5	2,000	31.5	1,800	32.4	1,900	35.4	1,400	39.0	1,200	40.1	1,100
45°	32.2	1,400	34.0	1,300	34.6	1,400	38.5	900				
40°	34.7	1,000	36.2	900								

C: Boom angle

R: Load radius (m)

W: Rated lifting capacity

RATED LIFTING CAPACITIES ISO4305

SPEC. SHEET NO. GR-700E-1-00212/EX-23

ON OUTRIGGERS

Unit : kg

Outriggers fully extended (6.7m) 360° Rotation												
A \ B	11.50		15.56		19.62		27.75		35.87		44.00	
	C		C		C		C		C		C	
3.0	68.7	70,000	74.8	47,000	78.1	40,000						
3.5	65.9	58,500	72.9	47,000	76.6	40,000						
4.0	63.0	53,600	70.7	47,000	75.0	40,000						
4.5	59.9	49,600	69.0	47,000	73.7	40,000	78.8	20,000				
5.0	57.2	45,100	66.8	43,100	72.1	37,300	77.7	20,000				
5.5	54.0	40,300	64.8	39,100	70.5	34,800	76.8	20,000				
6.0	50.6	36,300	62.7	35,600	69.1	32,800	75.7	20,000	79.6	14,000		
6.5	47.4	32,800	60.6	32,300	67.5	30,700	74.8	20,000	78.7	14,000		
7.0	43.7	29,800	58.4	29,200	65.8	28,200	73.7	20,000	78.0	14,000		
8.0	35.5	24,800	53.7	23,200	62.5	22,800	71.6	19,200	76.4	14,000	79.5	8,000
9.0	24.2	19,100	48.7	18,400	59.0	18,000	69.4	17,700	75.0	14,000	78.4	8,000
10.0			43.7	14,900	55.3	14,600	67.1	15,800	73.3	13,700	77.0	8,000
11.0			37.8	12,400	51.5	12,000	64.7	13,700	71.6	12,500	75.8	8,000
12.0			30.8	10,500	47.5	10,000	62.4	11,600	69.9	11,500	74.7	8,000
13.0			20.8	8,800	43.2	8,400	60.0	10,000	68.1	10,400	73.4	8,000
14.0					38.5	7,100	57.4	8,600	66.5	9,300	72.2	8,000
16.0							51.9	6,500	62.9	7,300	69.4	7,300
18.0							46.2	5,000	58.9	5,600	66.5	6,000
20.0							40.0	3,800	54.6	4,300	63.3	4,800
22.0							32.7	2,900	50.3	3,300	60.1	3,700
24.0							23.3	2,100	45.7	2,500	56.7	2,900
26.0									40.6	1,900	53.2	2,300
28.0									35.0	1,300	49.7	1,700
30.0											45.9	1,200
D	0°						18°			32°		
Telescoping conditions (%)												
2nd boom	0		50		100		100		100		100	
3rd boom	0		0		0		33		66		100	
4th boom	0		0		0		33		66		100	
Top boom	0		0		0		33		66		100	

- A: Boom length (m)
- B: Load radius (m)
- C: Loaded boom angle (°)
- D: Minimum boom angle for indicated boom length (no load)

ON OUTRIGGERS

Unit : kg

Outriggers extended to middle (6.7m) 360° Rotation												
C	44.0m Boom + 9.9m Jib						44.0m Boom + 17.7m Jib					
	3.5° offset		25° offset		45° offset		3.5° offset		25° offset		45° offset	
	R	W	R	W	R	W	R	W	R	W	R	W
80°	10.0	4,500	13.7	4,000	16.0	3,400	12.5	2,700	18.4	1,700	22.3	1,000
75°	15.1	4,500	18.7	3,900	20.3	3,300	18.6	2,700	23.7	1,700	27.1	1,000
70°	20.0	4,400	23.1	3,400	24.5	3,000	24.3	2,600	28.8	1,700	31.6	1,000
65°	24.2	3,300	27.1	3,000	28.5	2,700	29.2	2,200	33.4	1,600	35.7	1,000
60°	28.0	2,100	30.6	2,000	31.7	1,900	33.2	1,500	37.7	1,300	39.4	1,000
55°	31.6	1,300	34.0	1,200	34.8	1,200						

Outriggers extended to middle (6.7m) 360° Rotation												
C	35.87m Boom + 9.9m Jib						35.87m Boom + 17.7m Jib					
	3.5° offset		25° offset		45° offset		3.5° offset		25° offset		45° offset	
	R	W	R	W	R	W	R	W	R	W	R	W
80°	8.0	5,600	11.6	5,000	13.8	3,800	10.3	3,600	16.5	2,400	20.3	1,500
75°	12.2	5,600	15.4	4,500	17.4	3,600	15.2	3,600	21.1	2,400	24.4	1,500
70°	16.2	5,500	19.1	4,000	20.9	3,400	19.8	3,200	25.2	2,100	28.2	1,500
65°	19.9	4,500	22.5	3,500	24.1	3,000	24.2	2,700	29.0	1,900	31.6	1,500
60°	23.4	3,700	25.8	3,100	27.1	2,800	28.3	2,300	32.6	1,700	34.7	1,500
55°	26.5	2,600	28.7	2,300	29.8	2,100	31.9	1,700	35.9	1,500	37.5	1,400
50°	29.4	1,800	31.4	1,600	32.2	1,500	35.3	1,100	38.8	1,000	40.0	900
45°	32.1	1,200	33.8	1,000	34.4	1,000						

- C: Boom angle (°)
- R: Load radius (m)
- W: Rated lifting capacity

ON OUTRIGGERS

Unit : kg

Outriggers extended to minimum (2.8m)												
360° Rotation												
B \ A	11.50		15.56		19.62		27.75		35.87		44.00	
	C		C		C		C		C		C	
3.0	69.1	38,900	74.8	36,100	78.1	35,200						
3.5	66.1	30,200	72.7	28,400	76.4	27,700						
4.0	63.2	24,200	70.8	22,800	74.9	22,200						
4.5	60.2	19,800	68.7	28,600	73.4	18,200	78.8	19,200				
5.0	57.3	16,500	66.7	15,500	71.8	15,100	77.6	16,400				
5.5	54.1	14,000	64.7	13,100	70.1	12,800	76.5	14,200				
6.0	50.8	12,000	62.5	11,200	68.5	10,900	75.5	12,400	79.5	13,200		
6.5	47.6	10,400	60.3	9,600	66.9	9,300	74.4	10,800	78.6	11,600		
7.0	44.0	9,100	58.1	8,300	65.3	8,000	73.3	9,500	77.6	10,300		
8.0	35.9	6,900	53.5	6,200	62.1	5,900	71.0	7,400	76.0	8,100	79.5	8,000
9.0	24.9	5,200	48.8	4,700	58.4	4,400	68.8	5,800	74.3	6,500	78.1	6,900
11.0			43.4	2,500	54.9	2,200	66.4	3,600	72.5	4,200	76.7	4,700
10.0			37.7	3,500	51.1	3,200	64.1	4,600	70.9	5,200	75.3	5,700
12.0			30.7	1,700	46.9	1,400	61.7	2,700	69.2	3,300	73.9	3,800
13.0							59.3	2,000	67.3	2,600	72.4	3,000
14.0							56.6	1,400	65.7	2,000	70.9	2,400
D	0°		38°		46°		54°		62°			
Telescoping conditions (%)												
2nd boom	0		50		100		100		100		100	
3rd boom	0		0		0		33		66		100	
4th boom	0		0		0		33		66		100	
Top boom	0		0		0		33		66		100	

- A: Boom length (m)
- B: Load radius (m)
- C: Loaded boom angle (°)
- D: Minimum boom angle for indicated length (no load)

NOTES FOR “ON OUTRIGGERS” TABLE

1. Rated lifting capacities shown in the table are based on condition that crane is set on firm level surface. Those above bold lines are based on crane strength and those below, on its stability.
2. Rated lifting capacities based on crane stability are according to ISO 4305.
3. The mass of the hook (850 kg for 70t capacity, 470 kg for 40t capacity, 150 kg for 5.6 t capacity), slings and all similarly used load handling devices must be considered as part of the load and must be deducted from the lifting capacities.
4. For rated lifting capacity of single top, reduce the rated lifting capacities of relevant boom according to a weight reduction for auxiliary load handling equipment. Capacities of single top shall not exceed 5,600 kg including main hook.
5. Standard number of parts of line for each boom length is as shown below. Load per line should not surpass 54.9 kN {5,600 kgf} for main winch and auxiliary winch.

Boom length	11.5m	11.5m to 15.56m	15.56m to 19.62m	19.62m to 27.75m	27.75m to 44.0m	Single top / Jib
Number of parts of line	16	12	10	6	4	1

The lifting capacity data stored in the AUTOMATIC MOMENT LIMITER (AML-L) is based on the standard number of parts of line listed in the chart.

Maximum lifting capacity is restricted by the number of parts of line of AUTOMATIC MOMENT LIMITER (AML-L).

6. The lifting capacity for over-side area differs depending on the outrigger extension width. Work with the capacity corresponding to the extension width. The lifting capacities for over-front and over-rear areas are for “outriggers fully extended”. However, the areas (angle a) differ depending on the outrigger extension width.

Outriggers extended width	6.7m(middle)	5.5m(middle)	2.8m(minimum)
Angle a°	30	20	5

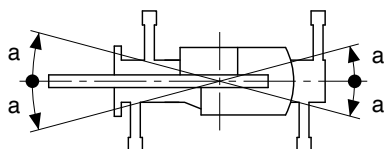

RATED LIFTING CAPACITIES ISO4305

SPEC. SHEET NO. GR-700E-1-00212/EX-23

ON TIRES

Unit : kg

		Stationary									
B	A	Over Front				360° Rotation					
		11.50		19.62		27.75		11.50		19.62	
		C		C		C		C		C	
3.0	69.0	33,000					68.7	22,200			
3.5	66.2	33,000					66.0	18,500			
4.0	63.2	33,000					63.2	14,700			
4.5	60.2	23,700					60.1	12,500			
5.0	57.4	21,500					57.1	10,500			
5.5	54.2	19,600					53.7	9,000			
6.0	50.9	17,000					50.5	7,500			
6.5	47.5	15,400	67.0	14,000			47.1	6,400	66.9	5,800	
7.0	44.1	13,800	65.3	12,100			43.8	5,500	65.2	4,800	
8.0	36.2	11,000	62.0	10,100			35.7	4,100	62.0	3,500	
9.0	25.0	8,800	58.7	8,000			23.9	3,100	58.8	2,300	
10.0			54.9	6,500	66.6	6,100					
11.0			51.4	5,100	64.3	5,200					
12.0			47.7	4,100	61.8	4,300					
13.0			43.7	3,200	59.3	3,600					
14.0			39.0	2,500	57.0	3,000					
16.0					52.3	2,000					
D			0°				18°				
Telescoping conditions (%)											
2nd boom		0		100		100		0		100	
3rd boom		0		0		33		0		0	
4th boom		0		0		33		0		0	
Top boom		0		0		33		0		0	

		Creep									
B	A	Over Front				360° Rotation					
		11.50		19.62		27.75		11.50		19.62	
		C		C		C		C		C	
3.0	69.0	25,500					68.9	17,100			
3.5	66.0	22,500					66.0	14,700			
4.0	63.1	20,000					63.3	12,700			
4.5	60.3	17,900					60.1	10,600			
5.0	56.9	16,300					57.3	8,800			
5.5	54.0	14,800					53.9	7,500			
6.0	50.6	13,500					50.8	6,500			
6.5	47.4	12,300	67.1	11,700			47.1	5,600	66.8	5,000	
7.0	43.6	11,300	65.5	10,700			43.8	4,900	65.1	4,200	
8.0	35.3	9,600	62.1	9,000			35.5	3,700	61.9	3,000	
9.0	24.1	8,000	58.6	7,100			24.7	2,700	58.3	2,100	
10.0			55.2	5,700	66.5	5,500					
11.0			51.4	4,600	64.2	4,800					
12.0			47.6	3,700	61.7	4,100					
13.0			43.8	2,900	59.5	3,500					
14.0			39.1	2,200	57.1	2,900					
16.0					52.2	2,000					
D			0°				18°				
Telescoping conditions (%)											
2nd boom		0		100		100		0		100	
3rd boom		0		0		33		0		0	
4th boom		0		0		33		0		0	
Top boom		0		0		33		0		0	

- A: Boom length (m)
- B: Load radius (m)
- C: Loaded boom angle (°)
- D: Minimum boom angle for indicated length (no load)

NOTES FOR "ON TIRES" TABLE

1. Rated lifting capacities shown in the table are based on condition that crane is set on firm level surface, with suspension lock applied. Those above bold lines are based on tire capacity and those below, on crane stability. They are based on actual working radii increased by tire deformation and boom deflection.
2. Rated lifting capacities based on crane stability are according to ISO 4305.
3. The mass of the hook (850 kg for 70t capacity, 470 kg for 40t capacity, 150 kg for 5.6t capacity), slings and all similarly used load handling devices must be considered as part of the load and must be deducted from the lifting capacities.
4. For rated lifting capacity of single top, reduce the rated lifting capacities of relevant boom according to weight reductions for auxiliary load handling equipment. Capacities of single top shall not exceed 5,600 kg including main hook.
5. On tires lifting with "jib" is not permitted. Maximum permissible boom length is 27.75 m (over front) and 19.62 m (360° rotation).
6. CREEP is motion for crane not to travel more than 60 m in any 30 minute period and to travel at the speed of less than 1.6 km/h.
7. During "CREEP" duties travel slowly and keep the lifting load as close to the ground as possible, and especially avoid any abrupt steering, accelerating or braking.
8. Do not operate the crane while carrying the load.
9. Tires should be inflated to their correct air pressure of 0.41 Mpa {4.2 kgf/cm²}.
10. For CREEP operation, set Drive select switch to "4-WHEEL(Lo)" and set gear shift lever to "1".
11. Standard number of parts of line for on tires operation should be according to the following table.
Load per line should not surpass 54.9 kN {5,600 kgf} for main winch and auxiliary winch.

Boom length	Over Front			360° Rotation	
	11.5m	19.62m	27.75m	11.5m	19.62m
Number of parts of line (Single top)	8(Stationary) 6(Creep) (1)	4 (1)	4 (1)	6 (1)	4 (1)

The lifting capacity data stored in the AUTOMATIC MOMENT LIMITER (AML-L) is based on the standard number of parts of line listed in the chart.

Maximum lifting capacity is restricted by the number of parts of line of AUTOMATIC MOMENT LIMITER (AML-L).

WORKING AREA

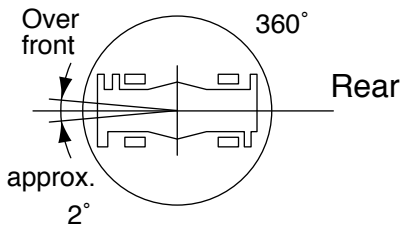

Without outriggers "Over front" operation should be performed within 2 degrees in front of chassis.

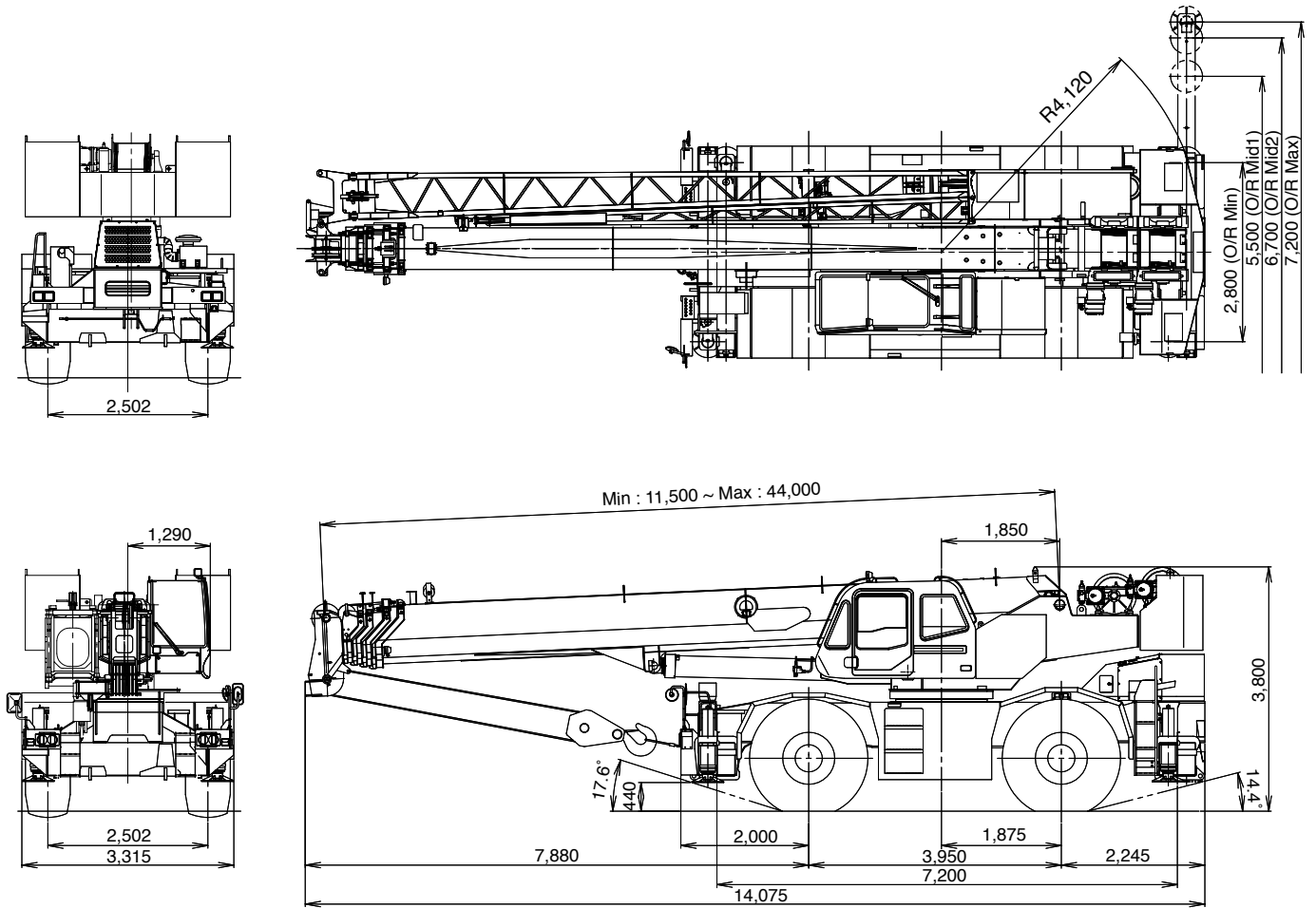

Note : Dimension is with boom angle at -2°.

Axle Weight Distribution Chart

Unit : kg

	GVW	Front	Rear
Basic standard machine includes: 5-section boom (11.5 m - 44.0 m) 2-stage jib (9.9 m, 17.7 m) Mitsubishi 6M60-TLU3B Single top 5.6 ton hook block	48,315	24,695	23,620
Add:			
1. 70 ton 8 sheaves hook block	+850	+1,530	-680
2. 40 ton 4 sheaves hook block	+470	+850	-380
3. Air conditioner	+ 97	+31	+66
Remove:			
1. 2-stage jib (9.9 m, 17.7 m)	-1,138	-2,006	+868
2. Removable counterweight	-7,900	+3,400	-11,300

Specifications are subject to change without notice.



TADANO

TADANO LTD. (International Division)

4-12, Kamezawa 2-chome,
Sumida-ku, Tokyo 130-0014, Japan

Tel : 81-(0)3-3621-7750

Fax : 81-(0)3-3621-7785

 <http://www.tadano.co.jp/indexe.htm>

 tdnihq@tadano.co.jp

Printed in Japan

GR-700EX-2007-07-1